



100 dagen feest

In deze download zitten de volgende bladen:

- **Twee kleurplaten:**

- Kleuren met tientallen
- Alle getallen tot 100. Bij deze versie zit een hulpkaart. De kinderen zoeken het getal op en bepalen de juiste kleur.

Lege vakken mogen naar eigen inzicht gekleurd worden.

- **Werkblad: Kleur de vorm en tel.** De antwoorden staan hieronder.

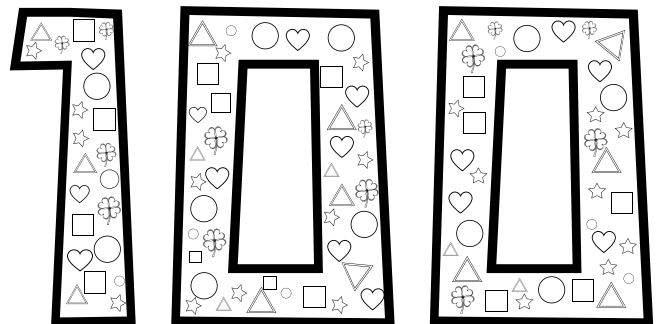

Antwoorden:



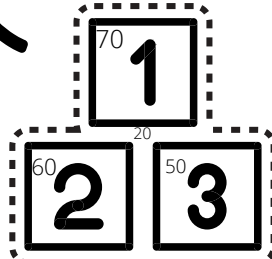
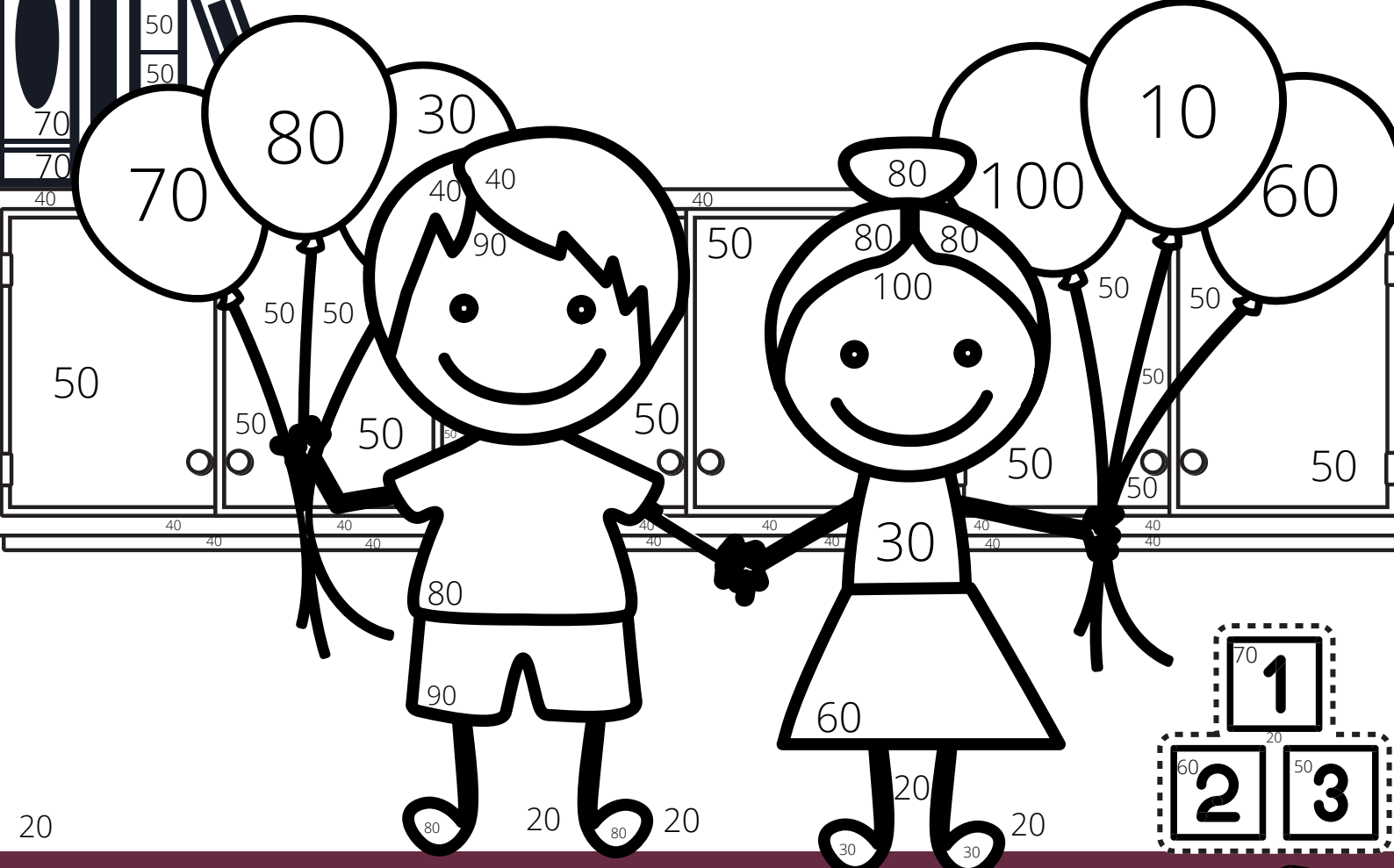
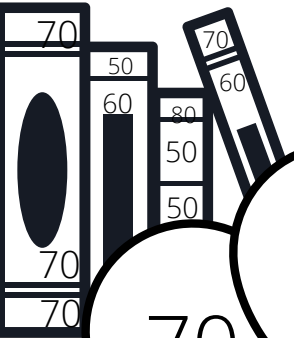
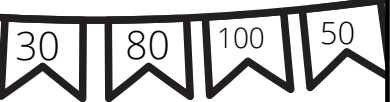
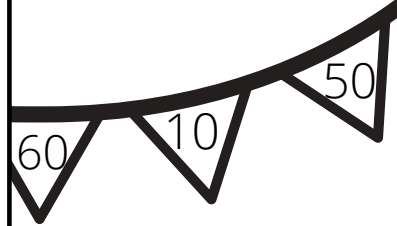
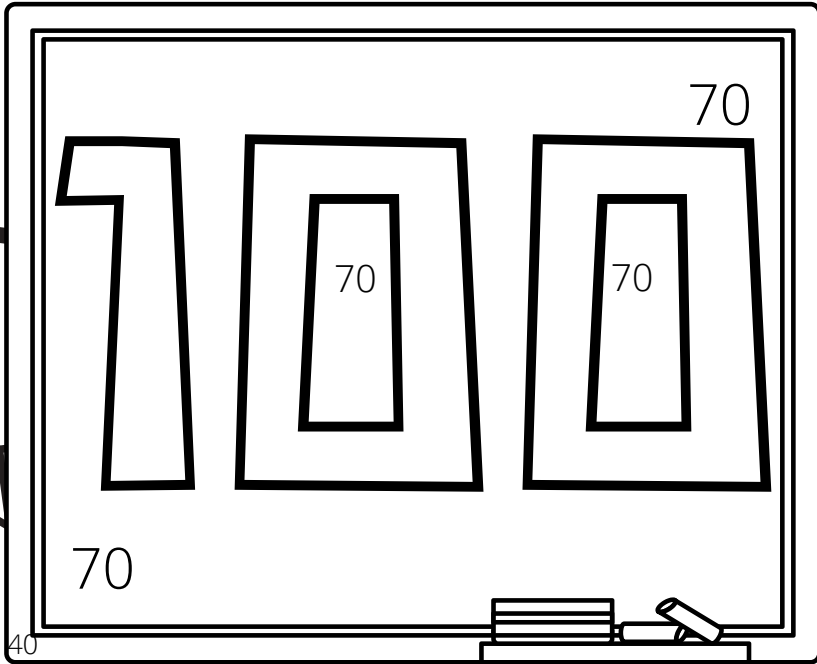
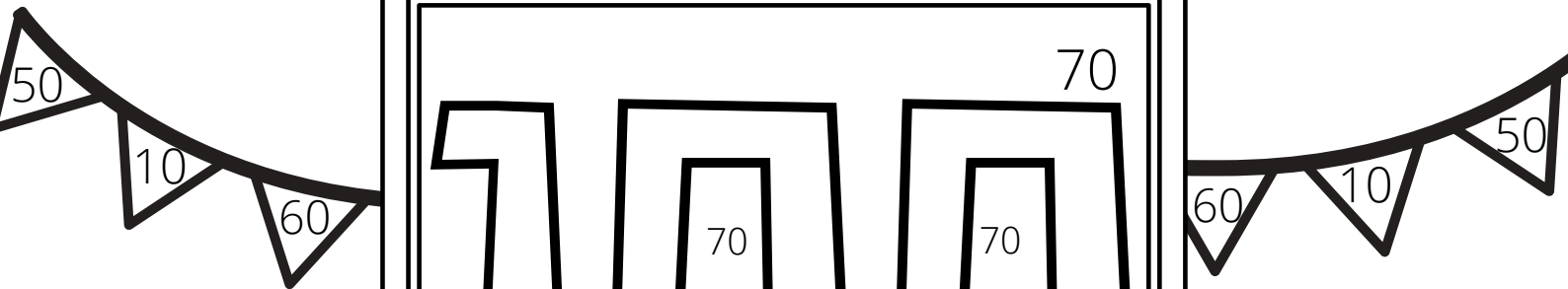
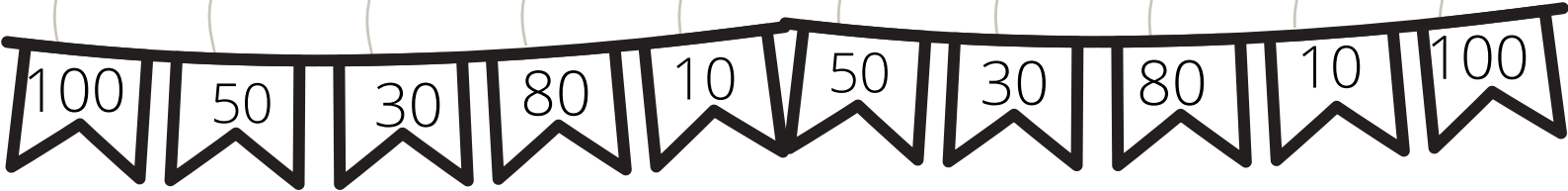
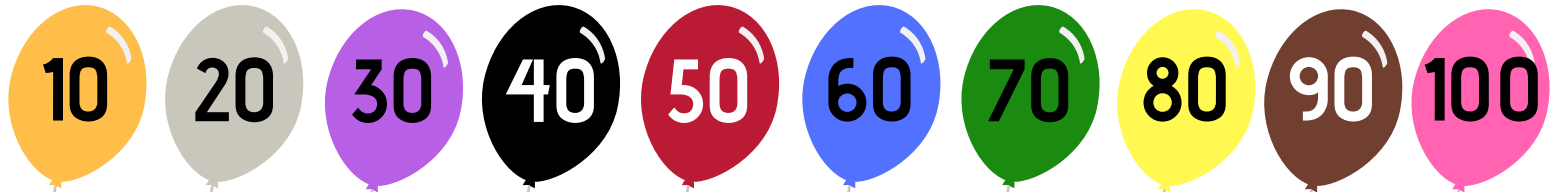

- 1 - 10
- 11 - 20
- 21 - 30
- 31 - 40
- 41 - 50
- 51 - 60
- 61 - 70
- 71 - 80
- 81 - 90
- 91 - 100

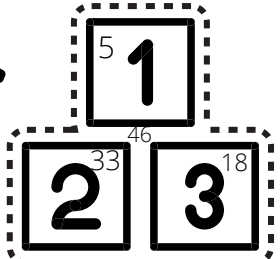
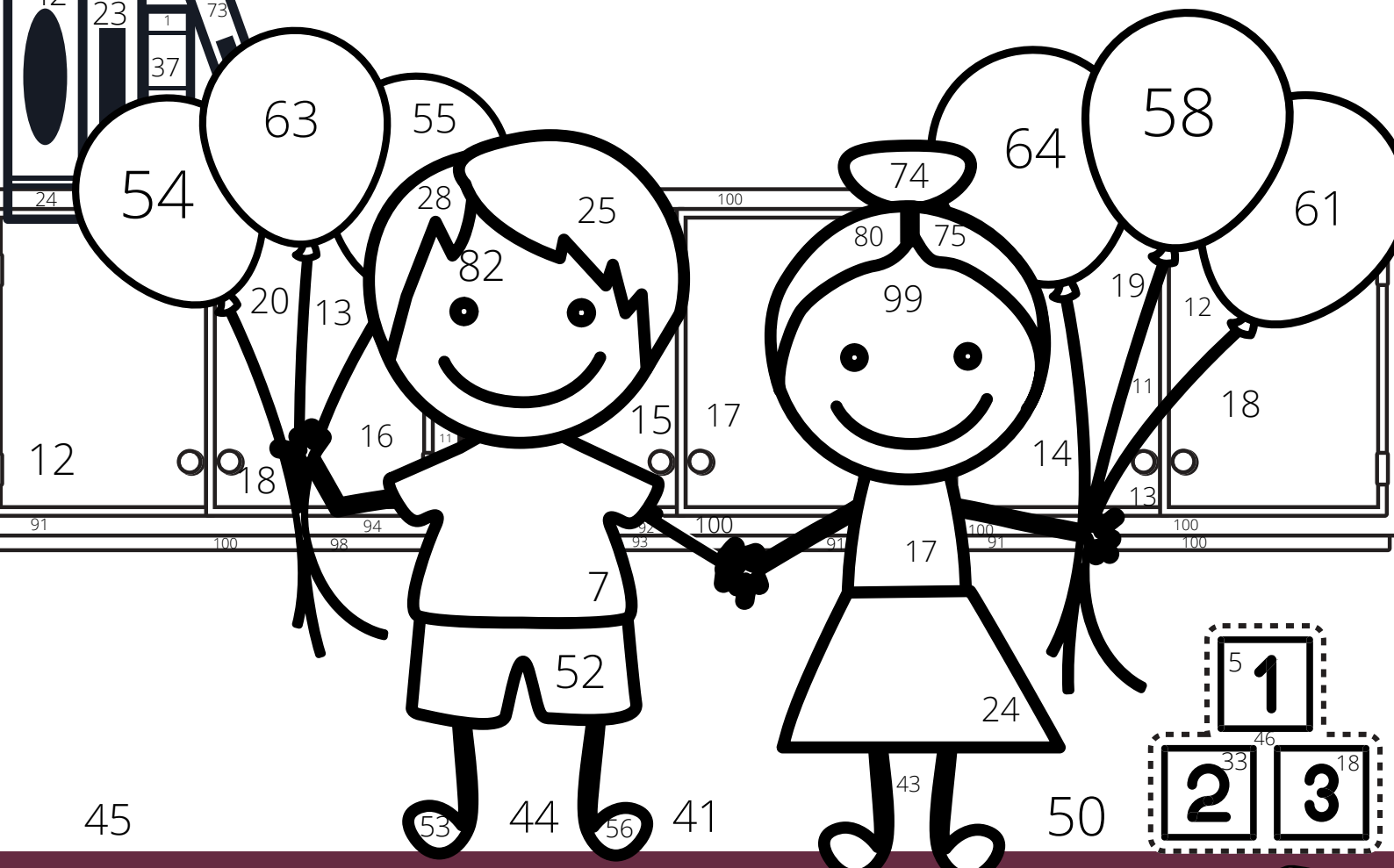
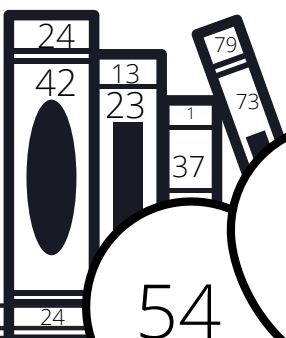
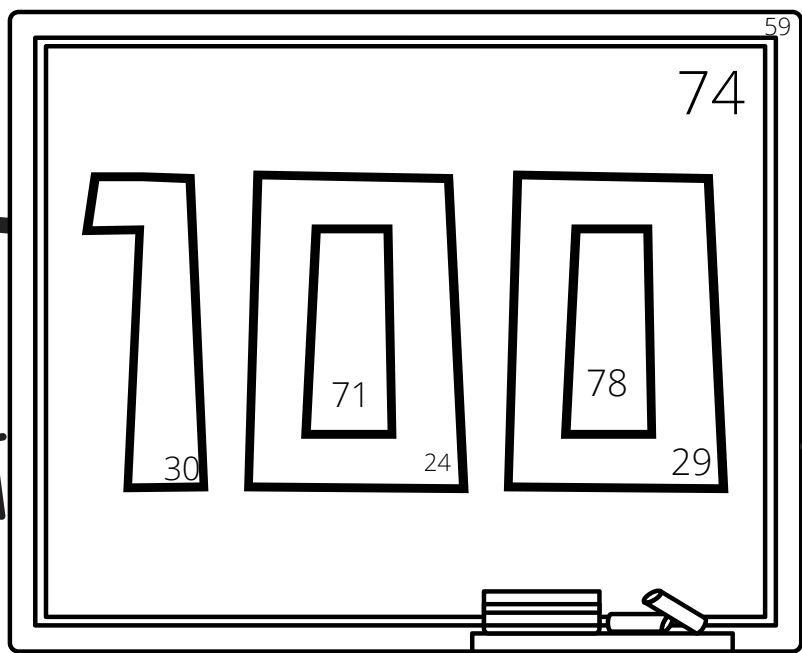
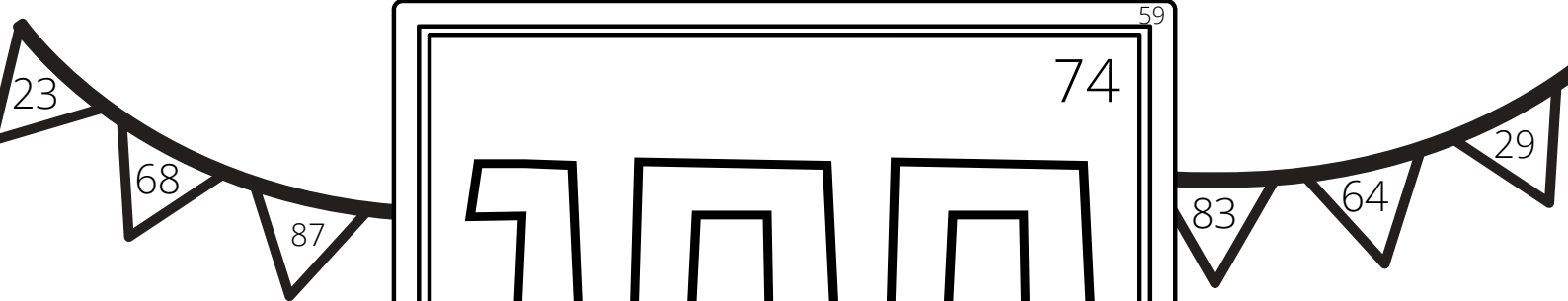
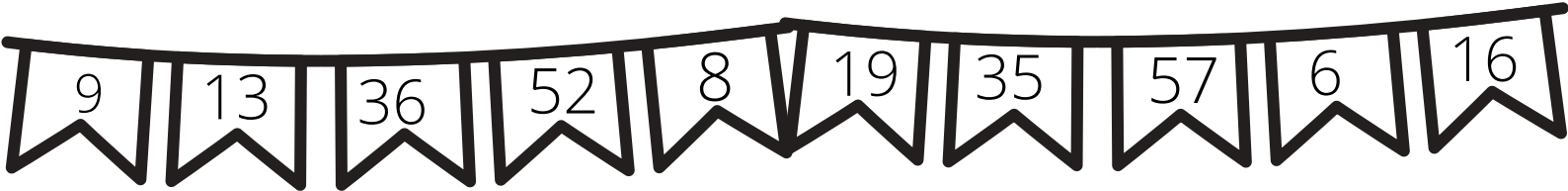

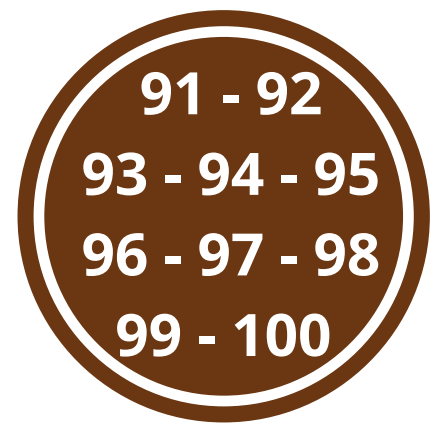
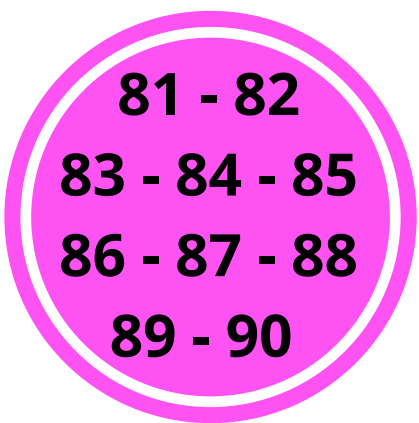
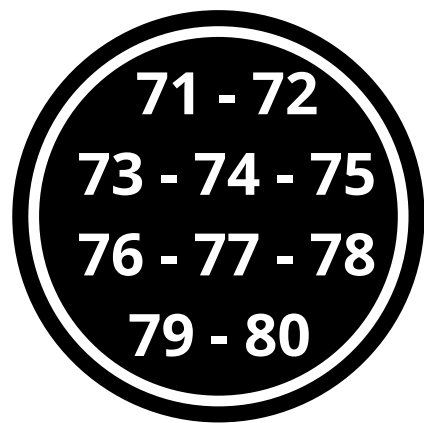
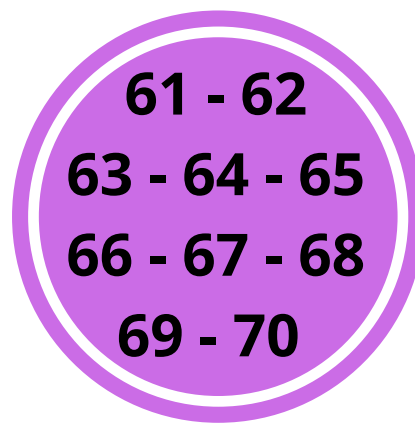
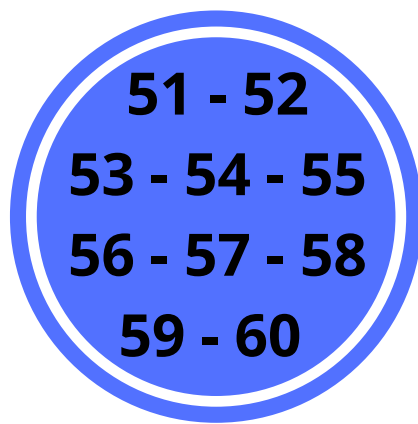
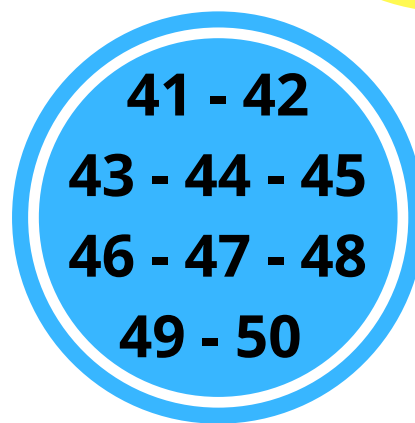
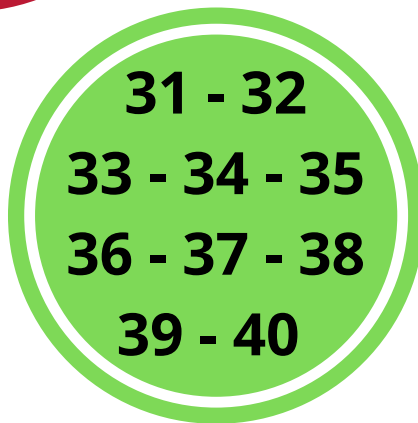
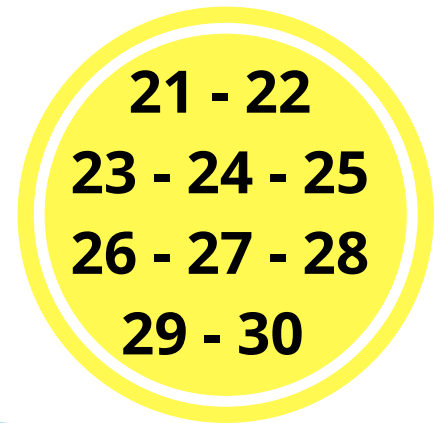
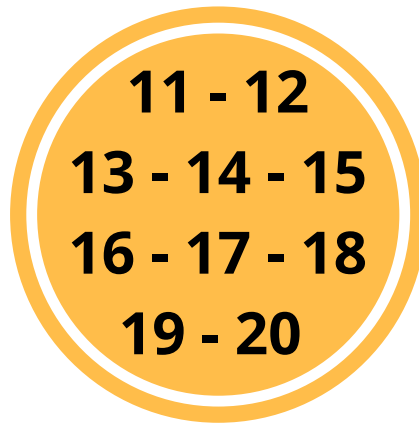
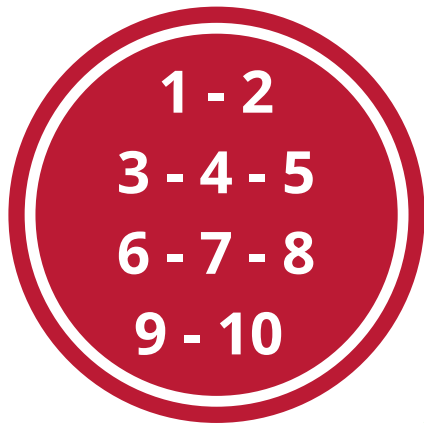

Kleur de vorm en tel

